

ENGINEERING DATA SHEET

F601

RELAY - NONLATCH
6 PDT, 10 AMP

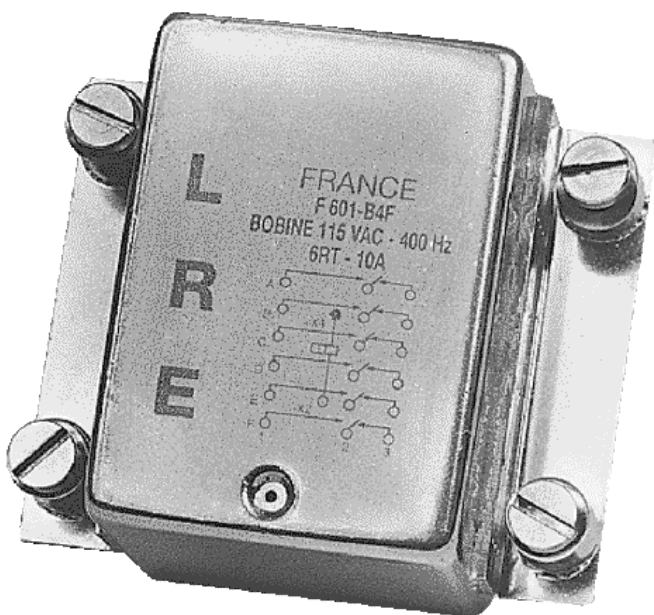

APPLICATION NOTES:

- [001](#)
- [002](#)
- [007](#)

APPLICABLE SOCKET:

- [S600](#)

Non latching hermetically sealed relay

Contact arrangement **6 PDT**
 Coil supply **Alternating current**
 Meets the standards and requirements of **MIL-PRF-6106-8**
CECC16101-020
CECC16303-806

PRINCIPLE TECHNICAL CHARACTERISTICS

Contacts rated at **10 Amps / 28 Vdc OR 115 Vac - 400 Hz**
 Weight **95 grams max**
 Dimensions of case **26mm x 25.7mm x 37.7mm max**
 Balanced-force design.
 Hermetically sealed, corrosion protected metal can.
 Intrinsically safe relay.

CONTACT ELECTRICAL CHARACTERISTICS

Minimum operating cycles	Contact rating per pole and load type	Load Current in Amps		
		@28 Vdc	@115 Vac 400 Hz	@115/200 Vac, 400 Hz 3Ø
100,000 cycles	resistive load	10	10	10
20,000 cycles	inductive load (L/R=5ms)	8	8	8
100,000 cycles	motor load	4	4	4
100,000 cycles	lamp load	2	2	2
50 cycles	resistive overload	40	60	
400,000 cycles	at 25% rated resistive load			



Leach International
www.leachintl.com

North America
6900 Orangethorpe Ave.
P.O. Box 5032
Buena Park, CA 90622 USA

Tel: (01) 714-736-7599
Fax: (01) 714-670-1145

Europe, SA
2 Rue Goethe
57430 Sarralbe
France

Tel: (33) 3 87 97 98 97
Fax: (33) 3 87 97 84 04

Asia-Pacific Ltd.
20/F Shing Hing Commercial Bldg.
21-27 Wing Kut Street
Central, Hong Kong

Tel: (852) 2 191 2886
Fax: (852) 2 389 5803

Data sheets are for initial product selection and comparison. Contact Leach International prior to choosing a component.

COIL CHARACTERISTICS (Vac)**F601**

	Vac/400 Hz	Vac/60-400 Hz
CODE	F	K
Nominal operating voltage	115	115
Maximum operating voltage	122	122
Maximum pickup voltage at +125° C	100	100
Guaranteed drop-out voltage at -65° C	5	5
Maximum coil current in Amps at +25° C	0.06	0.06
Temperature range	-45° C to +125° C	-45° C to +85° C

GENERAL CHARACTERISTICS

Dielectric Strength at sea level	
- Contacts to ground and between contacts	1250 VRMS / 50 Hz
- Coil to ground	1000 VRMS / 50 Hz
Dielectric strength at altitude 25,000 m (all points)	350 VRMS / 50 Hz
Initial insulation resistance at 500 Vdc	100 M Ω min
Sinusoidal vibration	30 G / 75 to 3000 Hz
Shock	50 G / 6 ms
Maximum contact opening time under vibration and shock	10 μ s
Operate time at nominal voltage	20 ms max
Release time	50 ms max
Bounce time	1 ms max
Contact voltage drop at nominal current	
- initial value	150 mV max
- after life	175 mV max

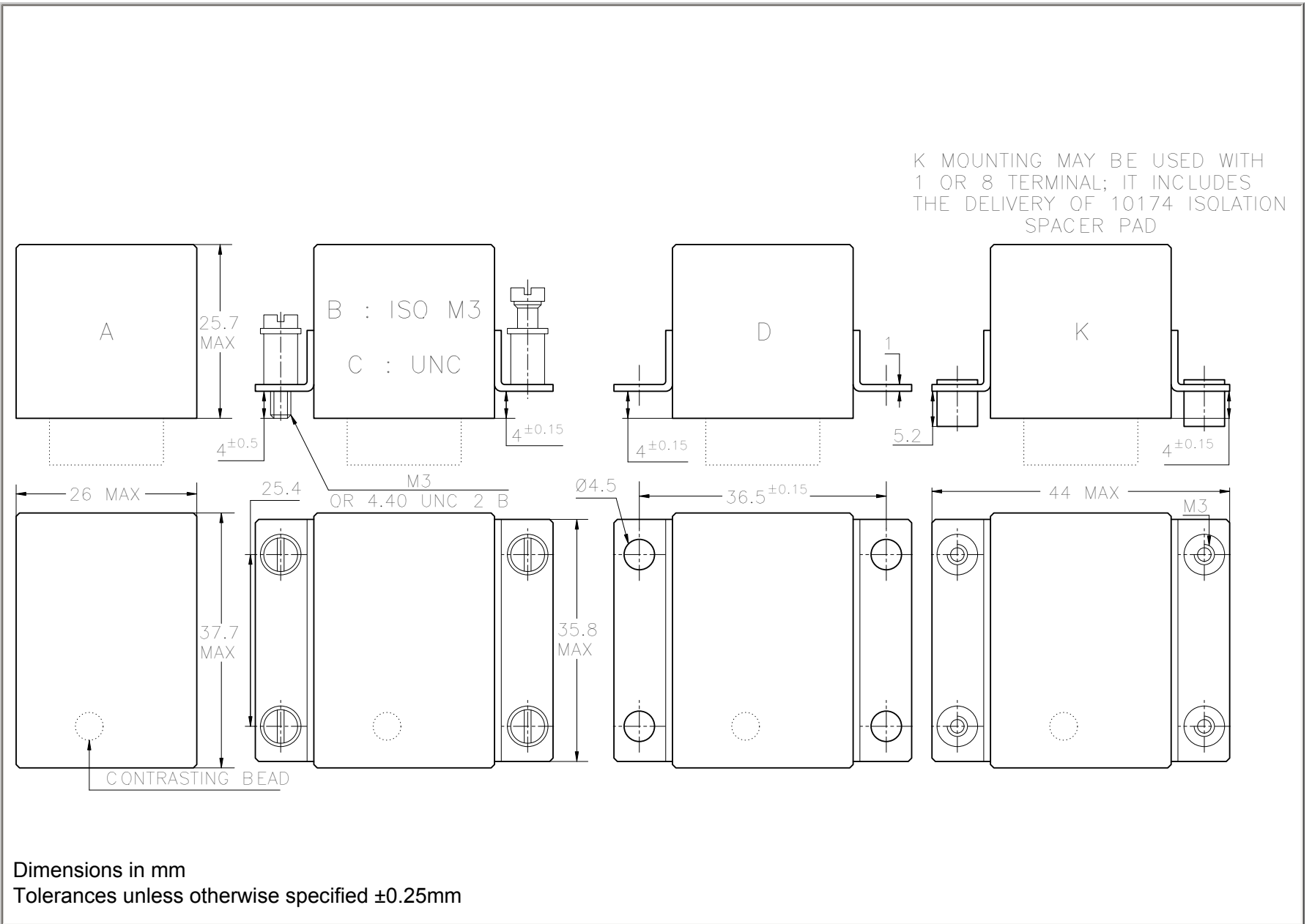

TERMINAL TYPES

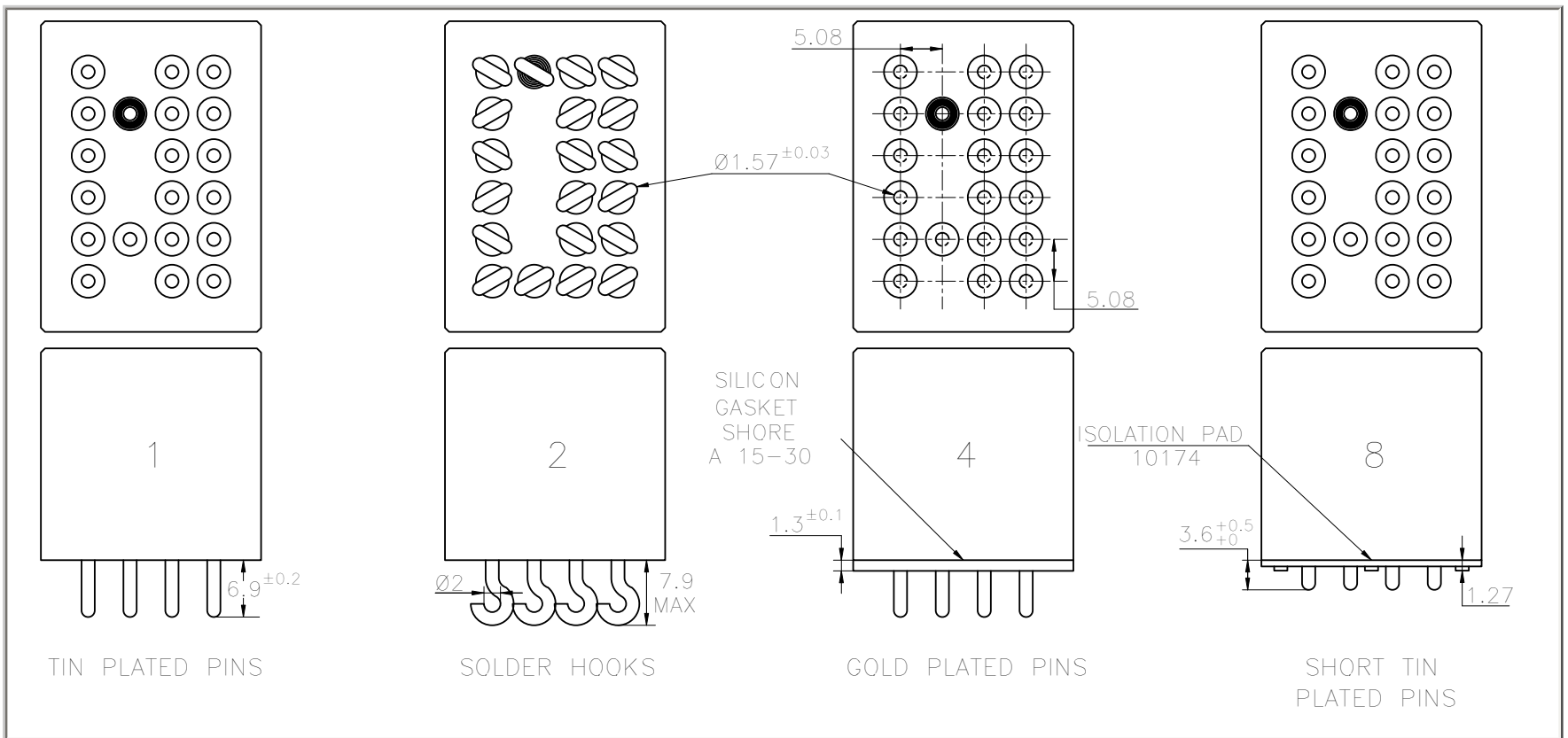

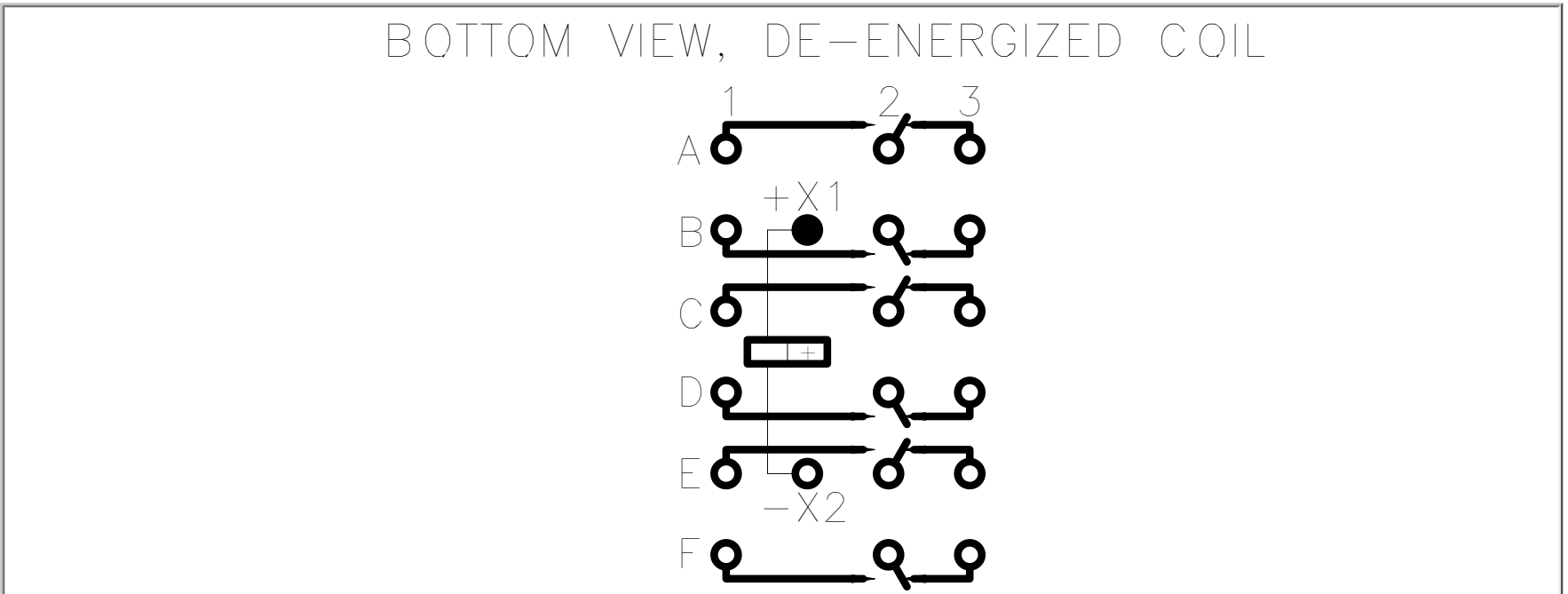

NUMBERING SYSTEM

	F601	-	B	4	F	C
Basic series designation _____						
1-Mounting Style (A,B,C,D,K) _____						
2-Terminal Types (1,2,4,8) _____						
3-Coil Voltage (F,K) _____						
4-See Note Below _____						

NOTES

1. Relays with mounting styles B,C,D and terminal type 4 are compatible with socket families S601, SF601...
2. Isolation spacer pads for PCB mounting available on request.
3. For other mounting styles or terminal types, please contact the factory.
4. **Options**
 - C:** Circuit breaker compatibility 15 A / 1 hour; 50 A / 5 sec; 100 A / 1.2 sec; 250 A / 0.2 sec; 350 A / 0.1 sec; 1400 A / 2 msec
 - D:** low level: 1 mAmp / 30 mV
 - H:** High current version, 15 Amps resistive contact rating

TYPICAL CHARACTERISTICS

- Coil resistance/temperature change: See application note no. 001
- Contact life expectancy for loads other than 28V: See application note no. 002

**CORRECTION DUE TO COIL COPPER WIRE RESISTANCE
CHANGE IN TEMPERATURE**

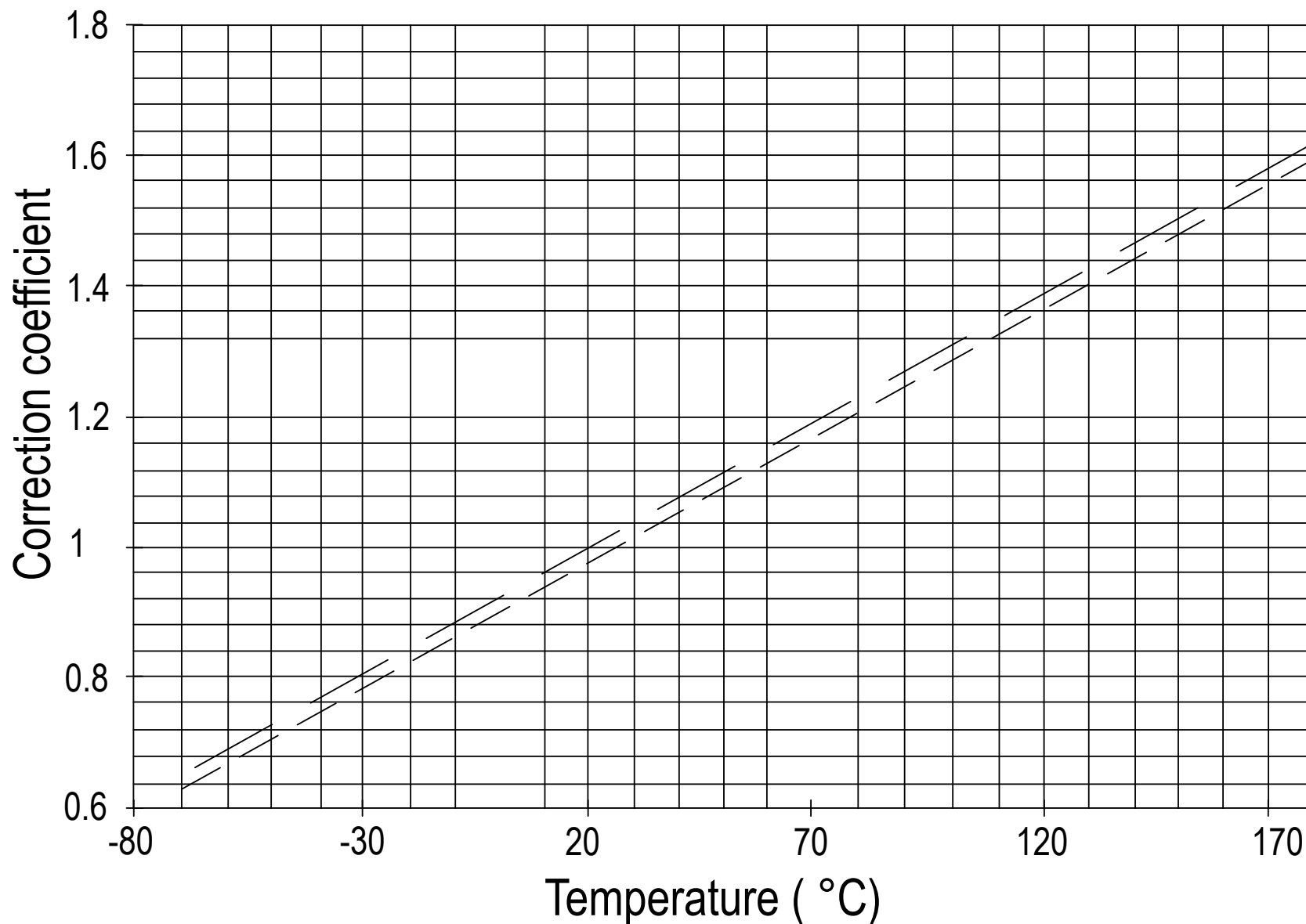

— — Nominal Resistance at 25°C

———— Nominal Resistance at 20°C

Example: Coil resistance at 25°C: 935 ohms. What is it at 125°C?

Correction coefficient on diagram is: 1.39 at 125°C. R becomes: $935 \times 1.39 = 1299$ Ohms

Correction also applies to operating voltages

LIFE CAPABILITY VERSUS VOLTAGE

Relay Series F/M30*, 40*, 60*

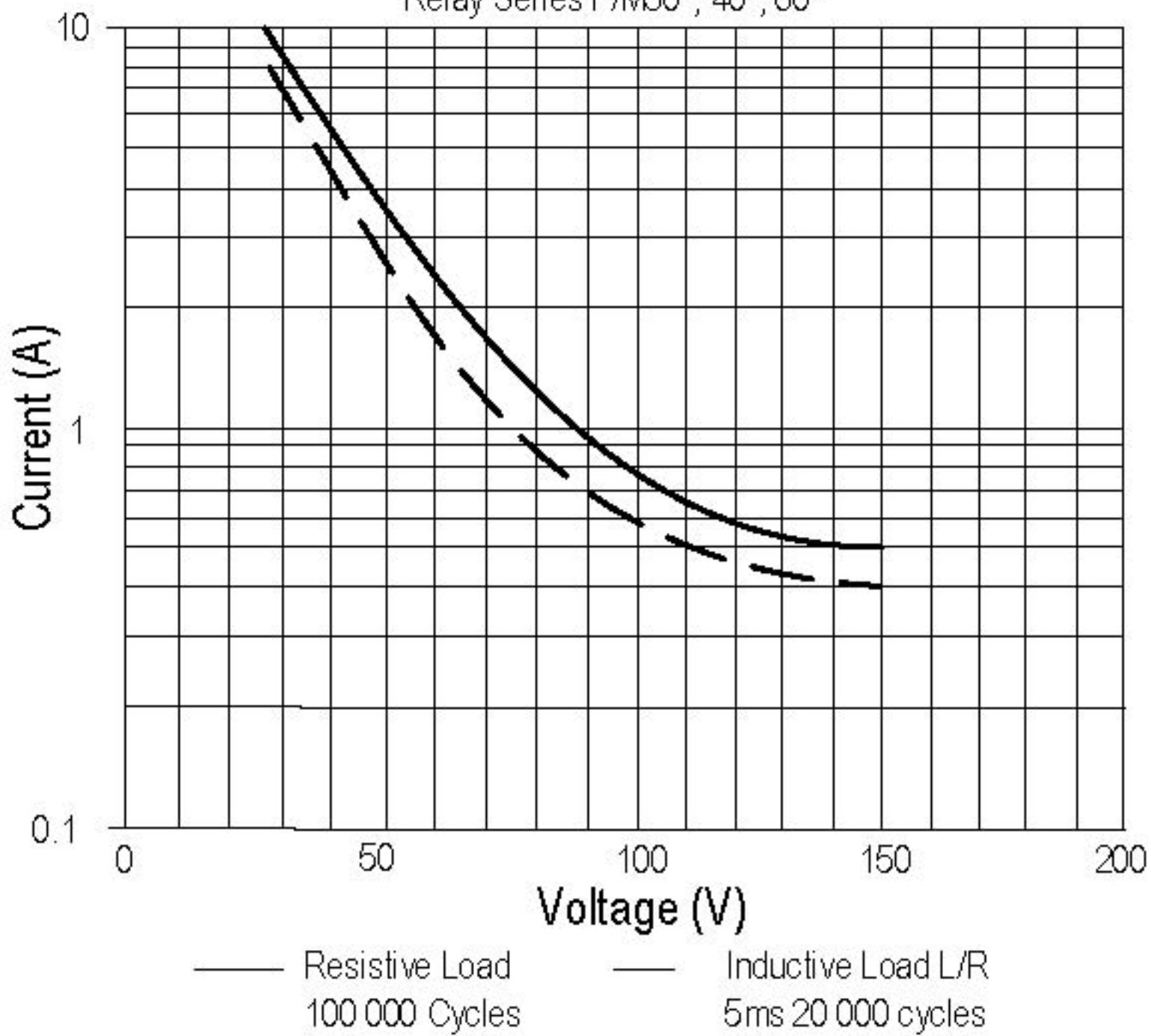

LIFE CAPABILITY VERSUS VOLTAGE

Relay Series FD 30,* 40*, 60*

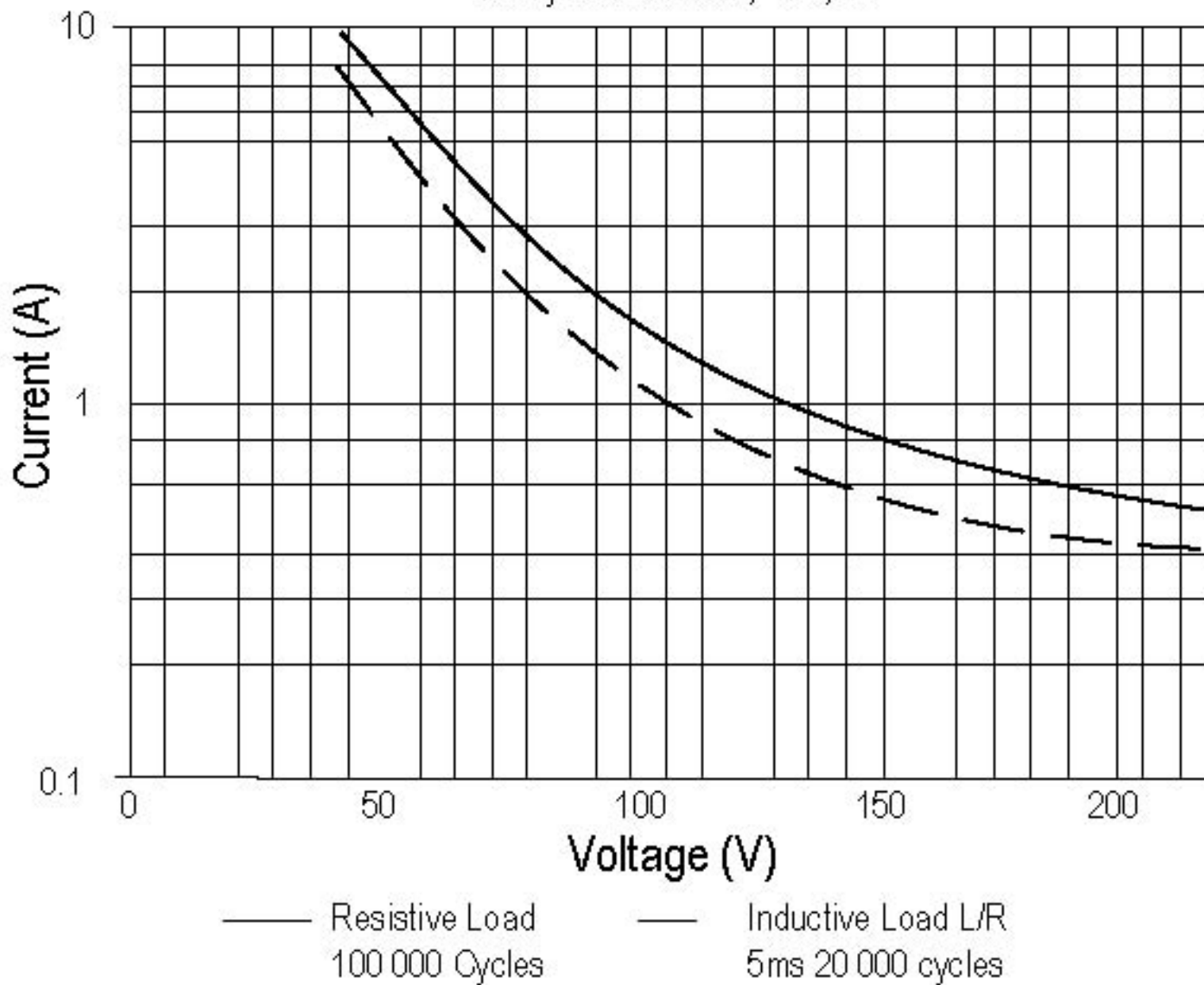

SUPPRESSOR DEVICES FOR RELAY COILS

The inductive nature of relay coils allows them to create magnetic forces which are converted to mechanical movements to operate contact systems. When voltage is applied to a coil, the resulting current generates a magnetic flux, creating mechanical work. Upon deenergizing the coil, the collapsing magnetic field induces a reverse voltage (also known as back EMF) which tends to maintain current flow in the coil. The induced voltage level mainly depends on the duration of the deenergization. The faster the switch-off, the higher the induced voltage.

All coil suppression networks are based on a reduction of speed of current decay. This reduction may also slow down the opening of contacts, adversely effecting contact life and reliability. Therefore, it is very important to have a clear understanding of these phenomena when designing a coil suppression circuitry.

Typical coil characteristics

On the graph below, the upper record shows the contacts state. (High level NO contacts closed, low level NC contacts closed, intermediate state contact transfer). The lower record shows the voltage across the coil when the current is switched off by another relay contact.

The surge voltage is limited to -300V by the arc generated across contact poles. Discharge duration is about 200 microseconds after which the current change does not generate sufficient voltage. The voltage decreases to the point where the contacts start to move, at this time, the voltage increases due to the energy contained in the NO contact springs. The voltage decreases again during transfer, and increases once more when the magnetic circuit is closed on permanent magnet.

Operating times are as follows:
 Time to start the movement 1.5ms
 Total motion time 2.3ms
 Transfer time 1.4ms

Contact State

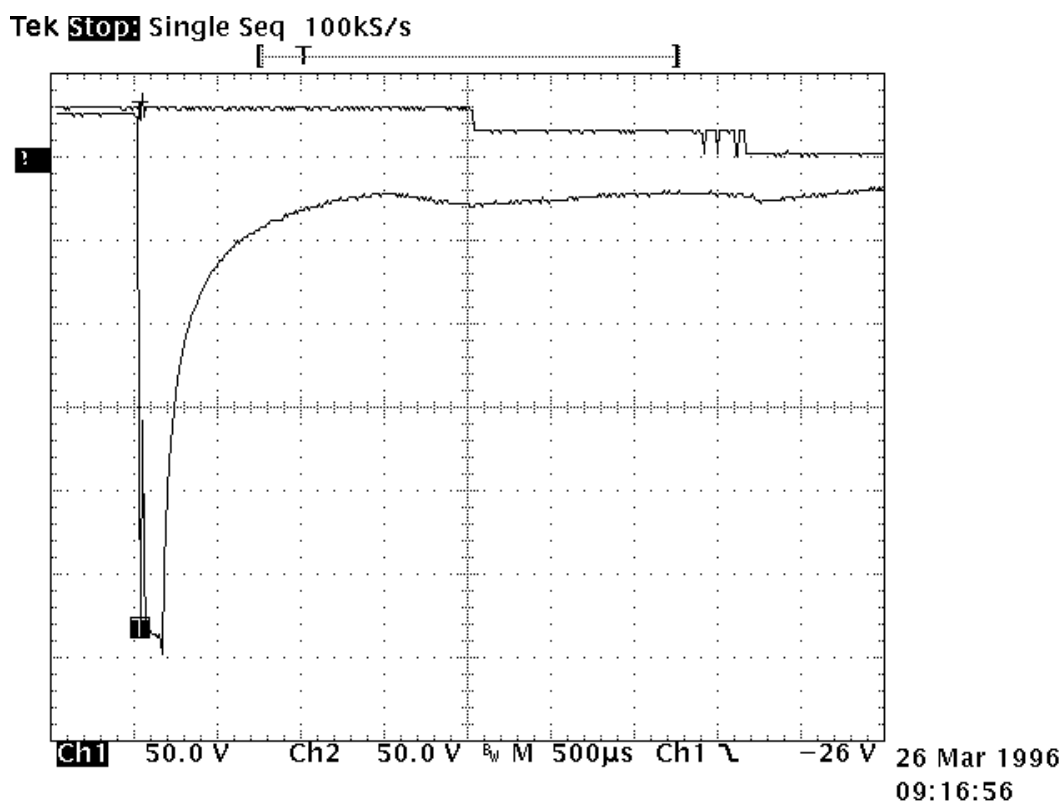

Types of suppressors:

Passive devices.

The resistor capacitor circuit

It eliminates the power dissipation problem, as well as fast voltage rises. With a proper match between coil and resistor, approximate capacitance value can be calculated from:

$$C = 0.02 \times T / R, \text{ where}$$

T = operating time in milliseconds

R = coil resistance in kiloOhms

C = capacitance in microFarads

The series resistor must be between 0.5 and 1 times the coil resistance. Special consideration must be taken for the capacitor inrush current in the case of a low resistance coil.

The record shown opposite is performed on the same relay as above. The operation time becomes:

- time to start the movement 2.3ms

- transfer time 1.2ms

The major difficulty comes from the capacitor volume. In our example of a relay with a 290Ω coil and time delay of 8 ms, a capacitance value of $C=0.5 \mu\text{F}$ is found. This non polarized capacitor, with a voltage of 63V minimum, has a volume of about 1cm^3 . For 150V, this volume becomes 1.5cm^3 .

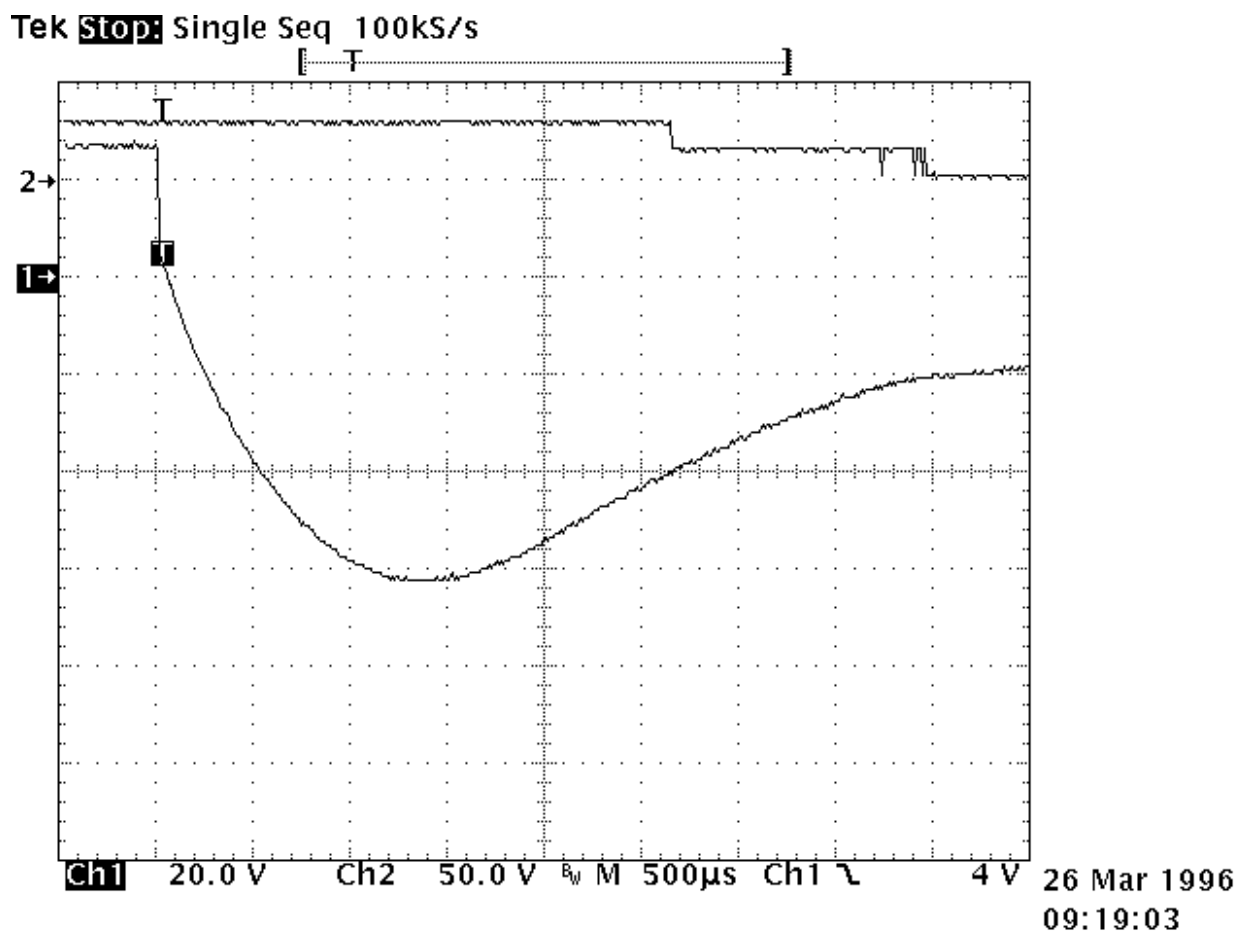

The bifilar coil

The principle is to wind on the magnetic circuit of the main coil a second coil shorted on itself. By a proper adaptation of the internal resistance of this second coil it is possible to find an acceptable equilibrium between surge voltage and reduction of the opening speed. To be efficient at fast voltage changes, the coupling of two coils must be perfect. This implies embedded windings. The volume occupied by the second coil reduces the efficiency of the main coil and results in higher coil power consumption. This method cannot be applied efficiently to products not specifically designed for this purpose.

The resistor (parallel with the coil)

For efficient action, the resistor must be of the same order of magnitude as the coil resistance. A resistor 1.5 times the coil resistance will limit the surge to 1.5 times the supply voltage. Release time and opening speed are moderately affected. The major problem is the extra power dissipated.

Semi-conductor devices

The diode

It is the most simple method to totally suppress the surge voltage. It has the major disadvantage of the higher reduction of contact opening speed. This is due to the total recycling, through the diode, of the energy contained in the coil itself. The following measurement is performed once again on the same relay. Operation times are given by the upper curve:

- time to start the movement 14ms
- transfer time 5ms

These times are multiplied by a coefficient from 4 to 8.

The lower curve shows the coil current. The increase prior to NO contact opening indicates that the contact spring dissipates its energy. At the opening time the current becomes constant as a result of practically zero opening speed.

Due to this kind of behavior, this type of suppression must be avoided for power relays. For small relays which have to switch low currents of less than 0.2 A, degradation of life is not that significant and the method may be acceptable.

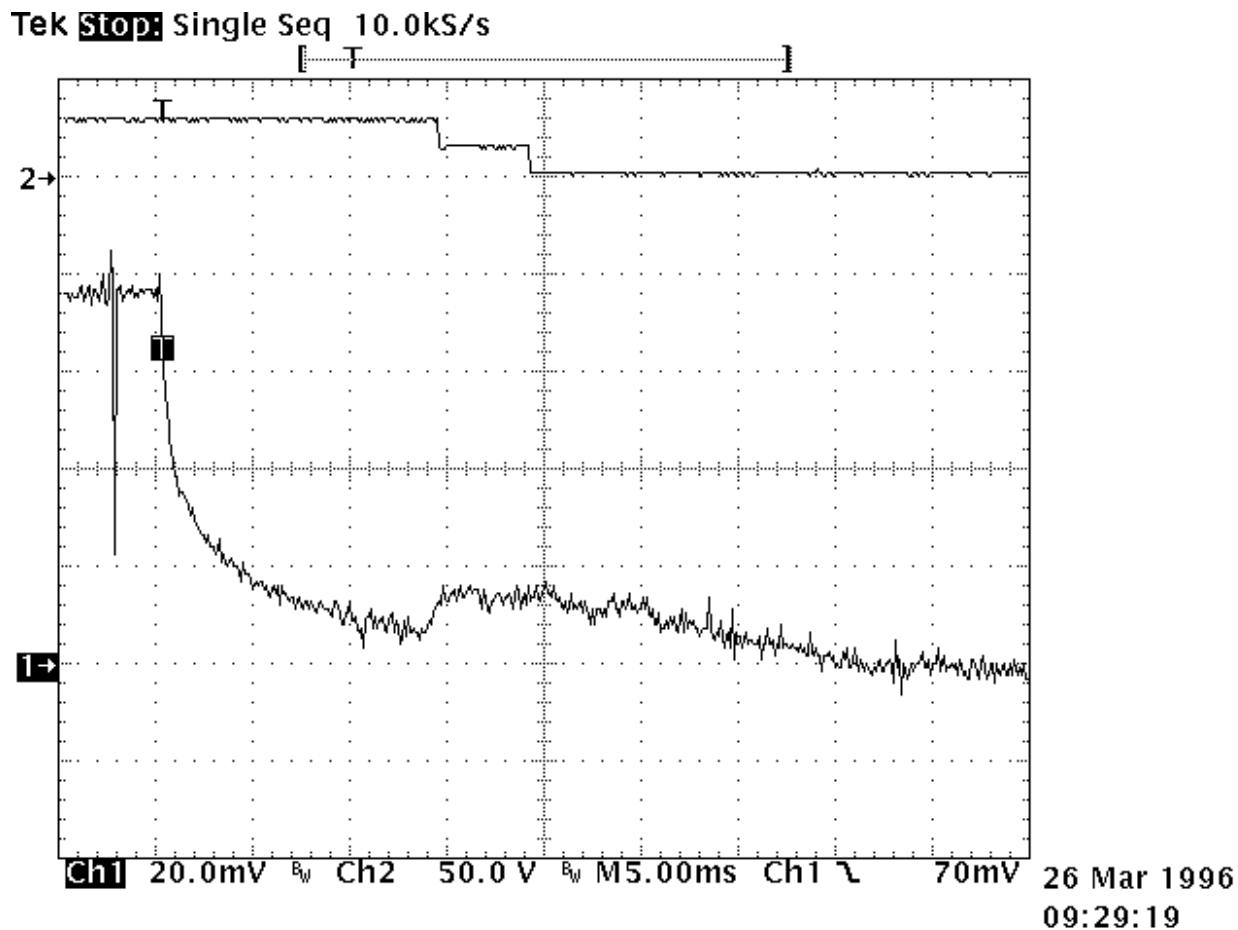

The diode + resistor network

It eliminates the inconvenience of the resistor alone, explained above, and it limits the action of a single diode. It is now preferred to use the diode + zener network.

The diode + zener network

Like the resistor, the zener allows a faster decurrent decay. In addition it introduces a threshold level for current conduction which avoids the recycling of energy released during contact movement.

The lower curve on the opposite record demonstrates those characteristics. Voltage limitation occurs at 42V. The two voltage spikes generated by internal movement are at lower levels than zener conduction. As a result, no current is recycled in the coil.

The opening time phases are as follows:

- time to start the movement 2.6ms
- total motion time 2.4ms
- transfer time 1.4ms

The release time is slightly increased. The contacts' opening speed remains unchanged.

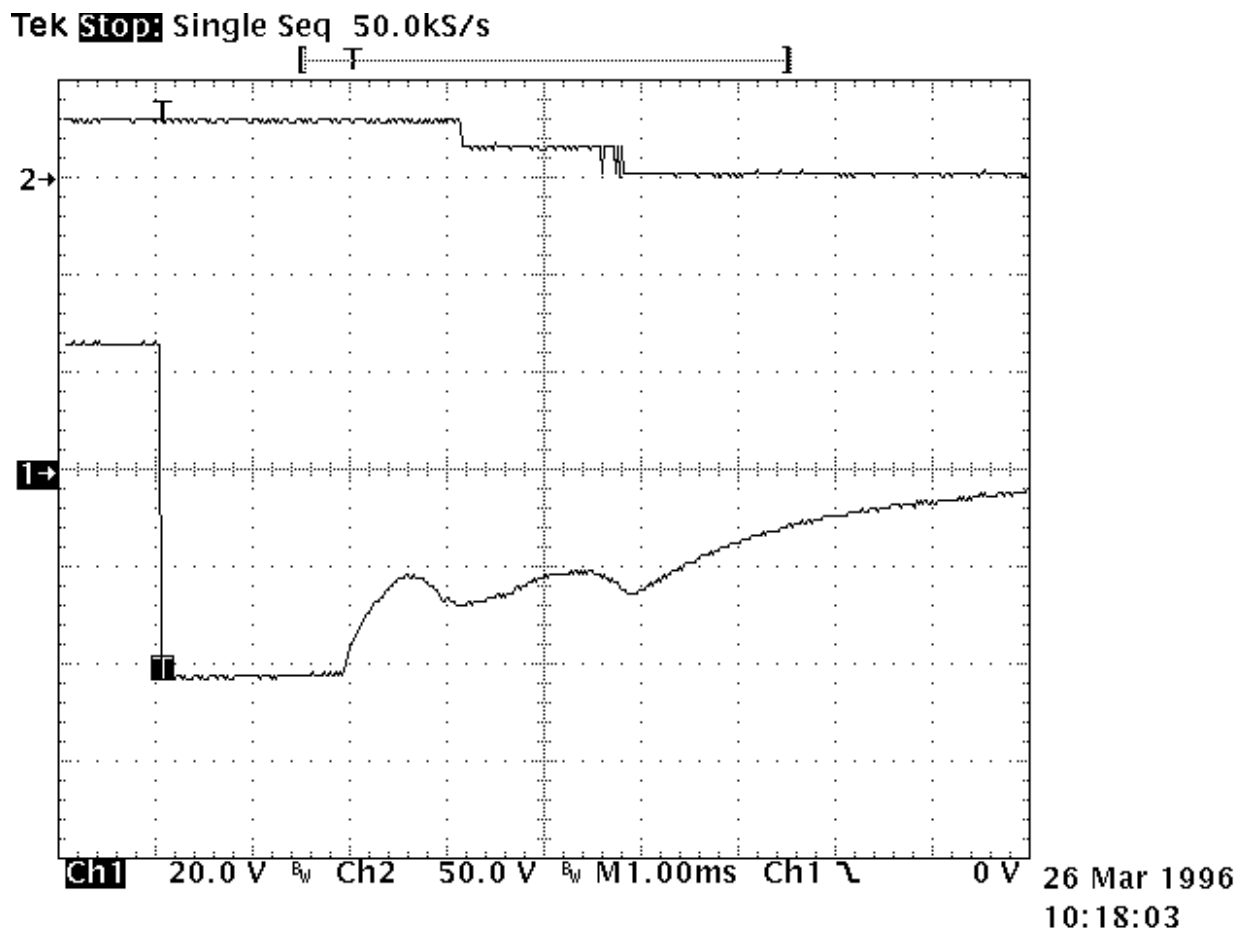

ENGINEERING DATA SHEET

S600/S601

SOCKET FOR 6 POLE RELAY
10 AMP



BASIC SOCKET SERIES DESIGNATION FOR:

SERIES F600, F601

In accordance with **MIL-S-12883/47**
For relays 6 PDT/10A **MIL-PRF-6106/8-CECC16101-020**

MATERIALS

Socket body **Thermoset plastic per MIL-M-14, SDG-F**
Grommet **Silicone rubber per ZZ-R-765**
Hardware **Stainless Steel**

GENERAL CHARACTERISTICS

Crimp tool for 16 gauge contacts	M22520/1-01 or 7-01; with positioner, M22520/1-02 or 7-03
Insertion and extraction tool	M81969/14-03
Weight	65g max.
Temperature range	-70C to +125°C

This connection is designed to the standards and requirements of Mil-S-12883/47 Contacts and hardware are provided disassembled in a plastic bag. Tolerances are $\pm 0.25\text{mm}$ unless otherwise noted.



Leach International
www.leachintl.com

North America
6900 Orangethorpe Ave.
P.O. Box 5032
Buena Park, CA 90622 USA

Tel: (01) 714-736-7599
Fax: (01) 714-670-1145

Europe, SA
2 Rue Goethe
57430 Sarralbe
France

Tel: (33) 3 87 97 98 97
Fax: (33) 3 87 97 84 04

Asia-Pacific Ltd.
20/F Shing Hing Commercial Bldg.
21-27 Wing Kut Street
Central, Hong Kong

Tel: (852) 2 191 2886
Fax: (852) 2 389 5803

Data sheets are for initial product selection and comparison. Contact Leach International prior to choosing a component.

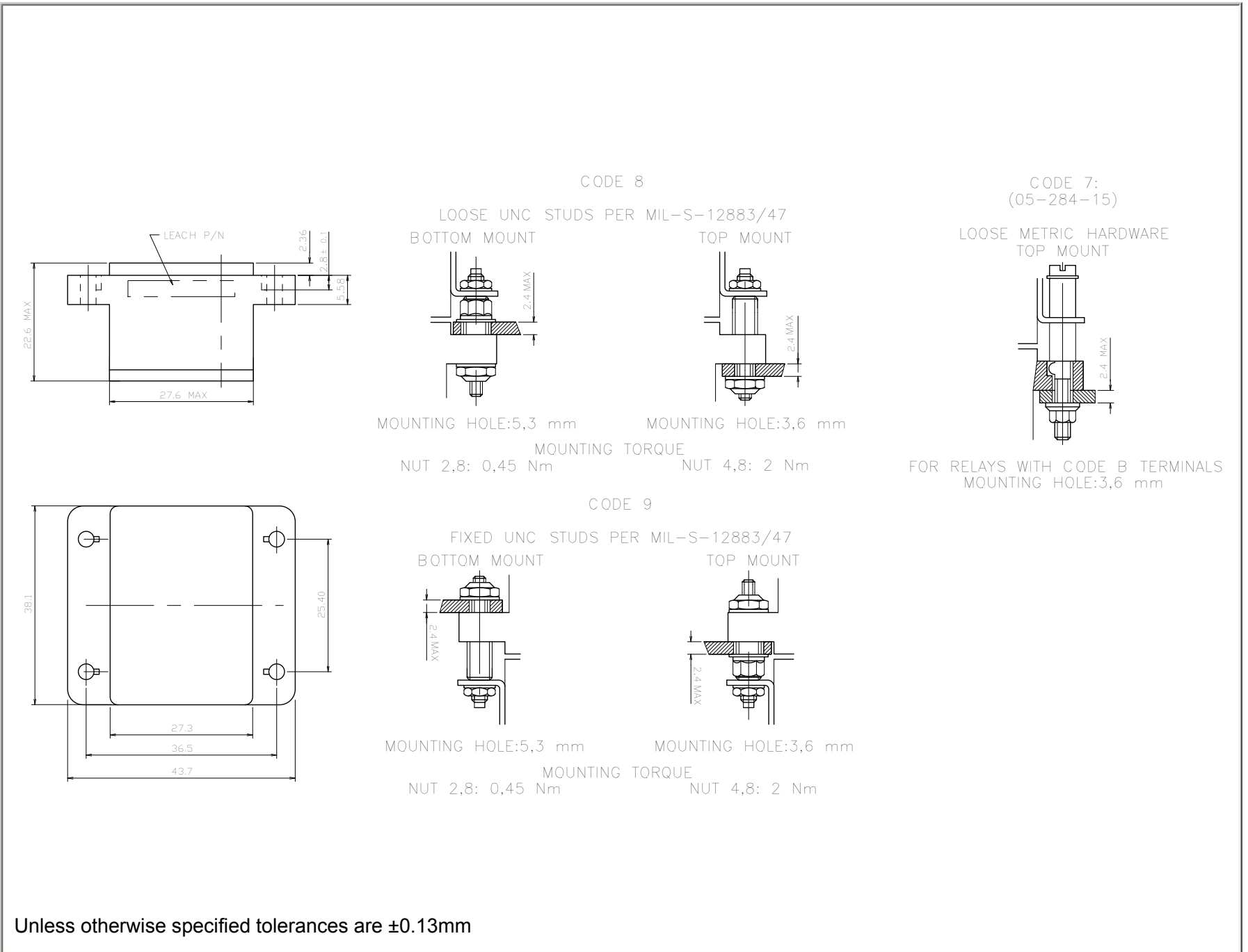

TERMINAL LAYOUT

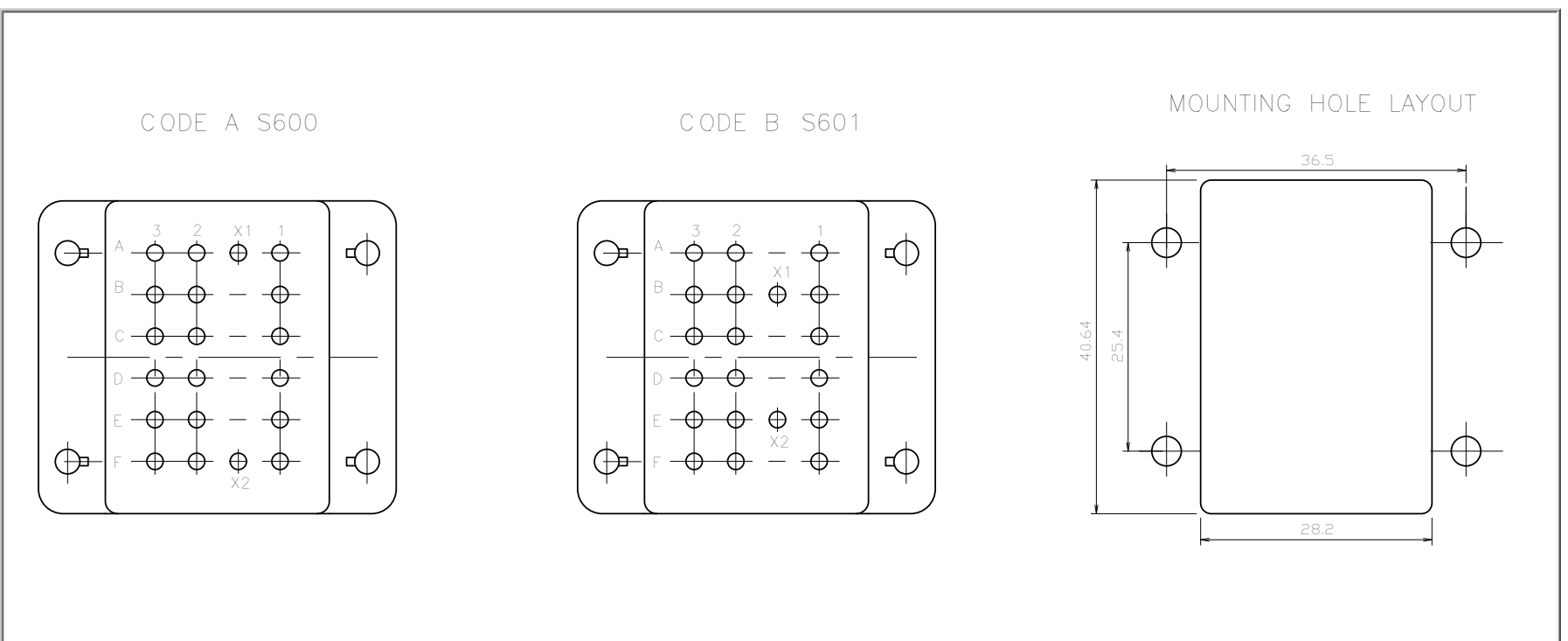

Code A	
Contact size 16-16	1.65mm to 2.76mm

CONTACT SIZE AND STYLE

Code 0 Contacts not supplied	Code 8 Coil Contacts (11-16-533) Insertion side: AWG 16-18-20 relay side: AWG 16 In accordance with Mil-C-39029-533 Quantity: 20
--	---

	S600	A	9	A	8
1-Basic Series Designation_____					
2-Terminal Types (A,B)_____					
3-Mounting Hardware (4,7,8,9)_____					
4-Grommet To Seal On Wire Insulation (A)_____					
5-Contacts Size And Styles (0,8)_____					

MS NUMBER CROSS REFERENCE

MS REFERENCE	S600/S601 REFERENCE
M12883/47-001	S600-A8A8
M12883/47-002	S601-B8A8
M12883/47-004	S600-A9A8
M12883/47-005	S601-B9A8

BASIC SOCKET SERIES DESIGNATION FOR:

SERIES F600, F670

Socket for printed circuit board mounting

DIMENSIONS

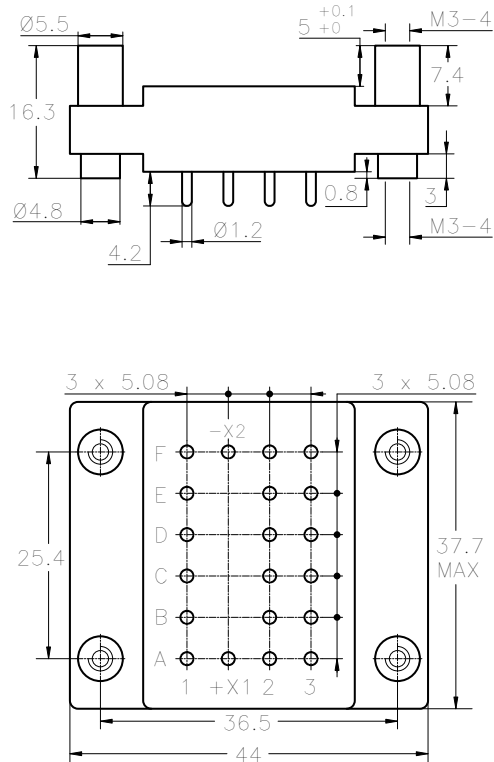

MOUNTING

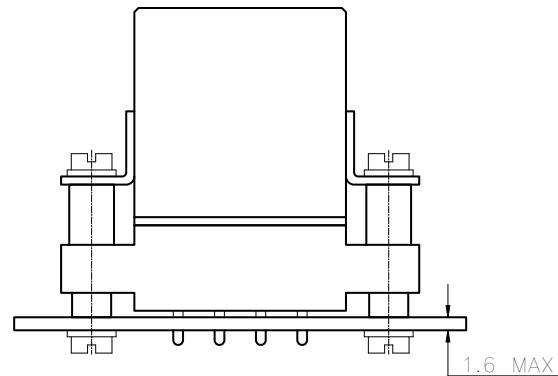

GENERAL CHARACTERISTICS

Temperature range	-55°C to +125°C
Storage Temperature	-70°C to +150°C
Insulation Resistance	> 1000 MΩ
Dielectric strength	
- Pins to mounting hardware	1500 Vrms / 50 Hz
- Between pins	1500 Vrms / 50 Hz
Sinusoidal vibration	20 g / 10 to 2000 Hz
Shock	50 g / 11 ms
Mounting hardware provided	8 screw M3-5



Leach International
www.leachintl.com

North America
6900 Orangethorpe Ave.
P.O. Box 5032
Buena Park, CA 90622 USA

Tel: (01) 714-736-7599
Fax: (01) 714-670-1145

Europe, SA
2 Rue Goethe
57430 Sarralbe
France

Tel: (33) 3 87 97 98 97
Fax: (33) 3 87 97 84 04

Asia-Pacific Ltd.
20/F Shing Hing Commercial Bldg.
21-27 Wing Kut Street
Central, Hong Kong

Tel: (852) 2 191 2886
Fax: (852) 2 389 5803

Data sheets are for initial product selection and comparison. Contact Leach International prior to choosing a component.